

SABRE SB35

Ultra-Slim Home Entertainment Soundbar with Compact Subwoofer

Owner's Manual



harman / kardon[®]
by HARMAN

SB35

INTRODUCTION	3
DESCRIPTION AND FEATURES	3
INCLUDED ITEMS	3
SABRE SB35 TOP PANEL CONTROLS	4
SABRE SB35 SUBWOOFER REAR PANEL CONTROLS	6
REMOTE CONTROL FUNCTIONS	7
PLACING THE SABRE SB35	7
PLACING THE SABRE SB35 ON A TABLE	7
WALL-MOUNTING THE SABRE SB35	8
PLACING THE SUBWOOFER ON FLOOR	8
WALL-MOUNTING THE SUBWOOFER	9
PLACING THE SUBWOOFER UNDER A COUCH OR FURNITURE	9
CONNECTIONS	9
AUDIO/VIDEO CONNECTIONS	9
POWER CONNECTIONS	10
OPERATION	10
TURNING THE SABRE SB35 ON AND OFF	10
TURNING THE SUBWOOFER ON AND OFF	11
PAIRING THE UNITS FOR WIRELESS OPERATION	11
FRONT PANEL AND ON-SCREEN INFORMATION DISPLAY (OSD)	11
OPERATING THROUGH BLUETOOTH®	11
SWITCHING SOURCE	12
ADJUSTING THE SABRE SB35'S VOLUME	12
MUTING THE SYSTEM	12
SABRE SB35 SURROUND MODE	12
SUBWOOFER CROSSOVER ADJUSTMENT	12
SUBWOOFER PHASE ADJUSTMENT (0-180°)	13
PROGRAMMING SABRE SB35 TO RESPOND TO YOUR TV REMOTE	13
RESETTING FACTORY DEFAULT SETTINGS	13
TROUBLESHOOTING	14
SPECIFICATIONS	15

Introduction

Thank you for purchasing the Harman Kardon® SABRE SB35 soundbar with which you are about to begin many years of listening enjoyment. The SABRE SB35 soundbar has been custom-designed to provide excitement and power of the cinema experience in your living room.

While sophisticated electronics and state-of-the-art speaker components are hard at work within the SABRE SB35, setup and operations are simple.

To obtain maximum enjoyment from your new soundbar speaker system, we urge you to take a few minutes to read through this manual, which:

- Contains a description of the features of SABRE SB35
- Lists the items included in the box
- Describes the SABRE SB35 and its components
- Includes step-by-step instructions that will help you set up and get started with SABRE SB35

In addition, a few minutes spent learning the functions of the various controls will allow you to take advantage of all the power and refinement of the SABRE SB35.

CONTACT US: If you have any questions about this product, its installation or its operation, please contact your retailer or custom installer, or visit our website at: www.harmankardon.com

Description and Features

The SABRE SB35 is a complete home theater system that includes:

- Ultra-thin 32 mm soundbar unit that complements the look and feel of your flat screen
- Exclusive Harman WAVE surround sound
- Complete HDMI® compatibility as well as Bluetooth® wireless connectivity
- Performance tuned drivers with a slim profile 100W wireless subwoofer
- Compatibility with the Harman Kardon Remote app for easy setup and advanced features
- Wall-mount brackets for the soundbar and subwoofer
- All cables supply

Exclusive Harman WAVE surround-mode technology uses extremely advanced Digital Signal Processing to deliver a realistic surround-sound experience for multiple listeners, no matter the shape and size of the room. The WAVE mode takes complete advantage of all surround channels. You can set the soundbar on a table in front of your TV, or mount it on a wall along with your flat-panel TV.

The SABRE SB35 subwoofer receives signal from the SABRE SB35 soundbar wirelessly, so you can place it anywhere in your room without having to run any wires. Its wireless 100W powered subwoofer delivers the full, intended impact and excitement from any movie. Programmable soundbar that can obey your TV remote's volume, power and source commands, enabling a single remote to control your whole home theater system. Adjustable subwoofer crossover helps you achieve a smooth transition of bass between the subwoofer and the soundbar for a variety of different rooms and

subwoofer locations. Phase switch lets you fine-tune bass performance to your listening environment.

Harman Kardon invented the high-fidelity stereo receiver more than 50 years ago. With state-of-the-art features and time-honored circuit design, the SABRE SB35 leverages this heritage to turn your flat-panel TV into a serious and exciting home cinema.

Included Items

The following are the accessories provided with the SABRE SB35 soundbar system:

- One Harman Kardon SABRE SB35 Home Theater Soundbar System



- One Power Supply Adapter with AC Cable

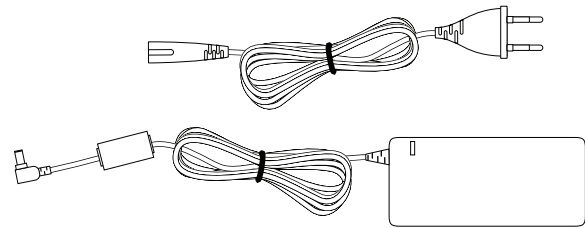

- One Analog Connector Cable

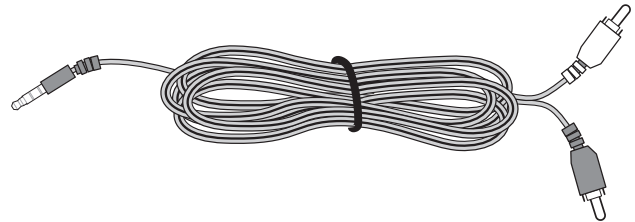

- One Optical Connector Cable

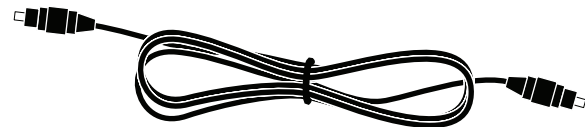

- One micro HDMI® to HDMI Cable

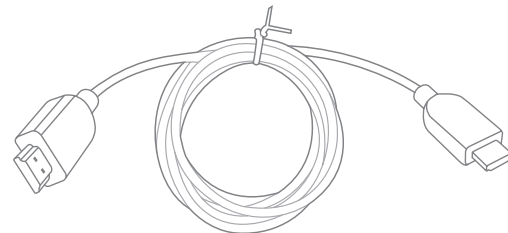

- One IR Repeater Cable



- One Remote Control

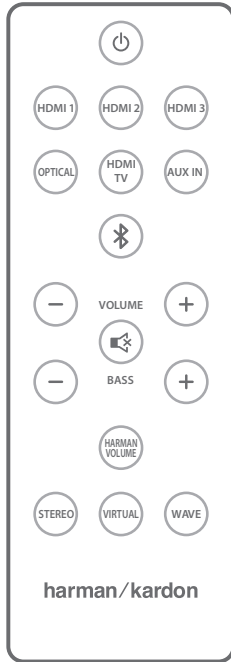

- Rubber pads



- One Harman Kardon SABRE SB35 Powered Wireless Subwoofer

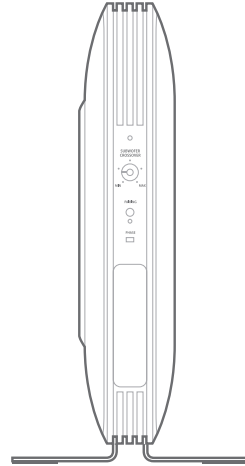

- One Soundbar Table Bracket

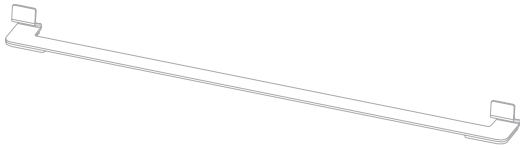

- One Soundbar Wall-mount Stand



- One Subwoofer Wall-mount Bracket

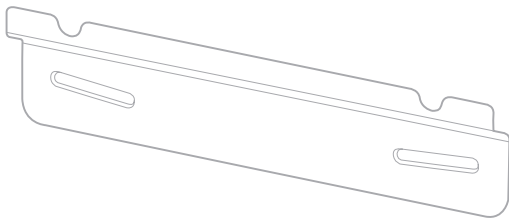

- One Subwoofer Floor Stand

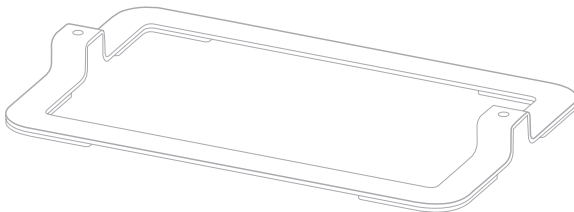

- One AC Cable

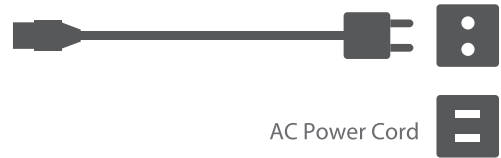

- One Quick-start Guide

SABRE SB35 Top Panel Controls

The top panel of the SABRE SB35 soundbar includes the following controls:

- Power
- Bluetooth®
- Volume Down
- Volume Up
- Surround Sound
- Source

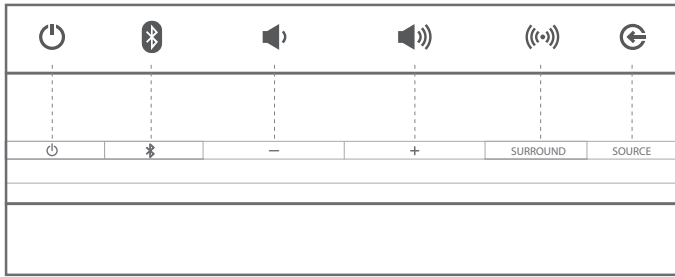

Power Button: The Power button turns the SABRE SB35 ON/OFF. When the SABRE SB35 is in Standby mode (Power Indicator is amber), press this button to turn the SABRE SB35 system ON (Power Indicator turns white).

NOTE: When the SABRE SB35 goes automatically to Standby mode, it will automatically turn ON whenever it detects an audio signal at the Source inputs. The SB35 will also automatically wake up from the following sources if it was on those sources before going to auto-standby.

- Optical audio input
- Analog audio input

For example, if the source input is analog audio when the SABRE SB35 goes to automatic Standby, it does not wake up even if it senses an audio signal from the optical audio input.

When the SABRE SB35 system is ON, short press the Power button to put the system in Standby mode (The Power Indicator turns amber).

NOTE: The system will remain ON for approximately 10 minutes after the audio signal ceases, and will then automatically go into the Standby mode.

Bluetooth (BT): This button pairs your system with other Bluetooth-enabled devices.

NOTE: SB 35's Bluetooth device name is SABRE SB35.

Volume Up/Down Buttons: Press the (–) button to reduce the volume; press the (+) button to increase the volume.

NOTE: Pressing both the SABRE SB35's Volume buttons at the same time while the system is ON will mute the system. Pressing either Volume buttons while the system is mute will restore the sound.

Surround Mode Button: This button turns the SABRE SB35 system's Harman WAVE or Virtual Surround processing ON and OFF. The text will be displayed on the panel display appropriately.

Source Button: Press the SABRE SB35's Source button to cycle between the sources in the following order:

1. Bluetooth
2. AUX input
3. Digital Optical In
4. HDMI ARC
5. HDMI 1
6. HDMI 2
7. HDMI 3

SABRE SB35 Rear Panel Controls and Connections

The rear panel of the SABRE SB35 soundbar includes the following:

1. Subwoofer pairing button
2. AUX input (analog audio in)
3. Optical (digital optical audio in)
4. Power input DC
5. IR transmitter (optional)
6. USB port (software update only)
7. HDMI 3 (HDMI input)
8. HDMI 2 (HDMI input)
9. HDMI 1 (HDMI input)
10. HDMI TV (support Audio Return Channel)

Subwoofer pairing button: Press the subwoofer pairing button to initiate pairing between soundbar and the wireless subwoofer.

AUX input (analog audio in): Connect your system to other devices using an AUX cable.

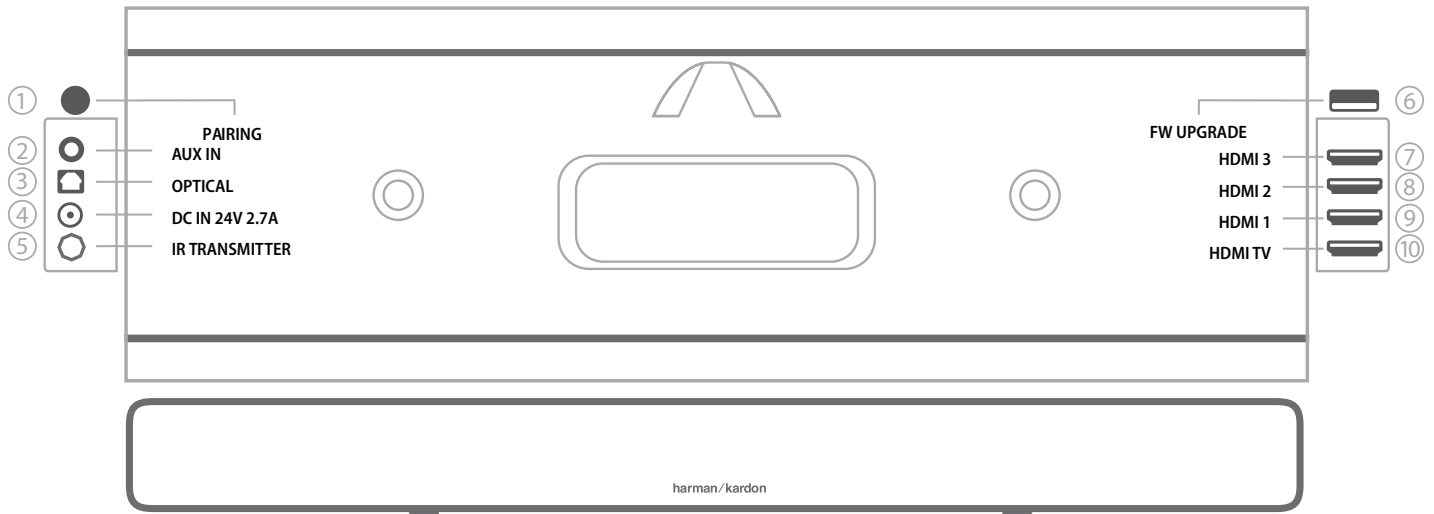

Optical (digital optical audio in): If your TV, disc player or cable/satellite tuner has an optical digital output, use the included optical cable to connect it here.

Power input DC: Connect the included power supply to this port.

IR Transmitter (Optional): Although the SB35 can be wall-mounted, most customers place their soundbar on a TV stand. This can be problematic as it may block the TV's remote control sensor, forcing you to stand up and angle your remote to control your TV. In this case, we recommend you to use the supplied IR Repeater.

To install the IR Repeater:

1. Plug the supplied IR Repeater cable to the back of the SB35.
2. Place the IR Repeater on the back of the SB35 in front of the TV IR Receiver.

The television IR command will automatically transmit from the IR receiver of the SB35 to the IR receiver of the television.

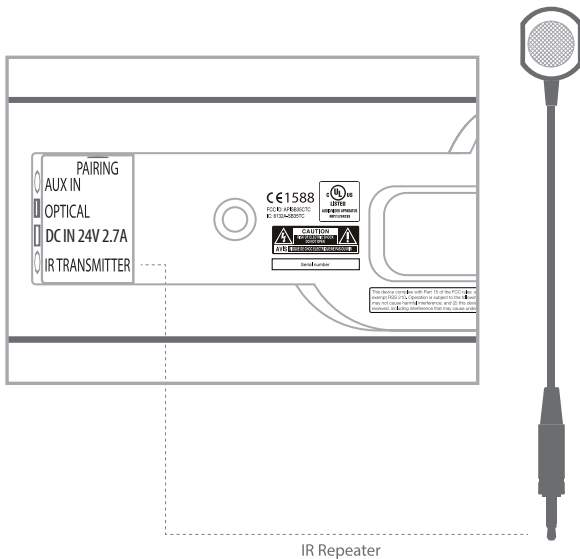

USB Port: The USB port is only for software upgrade. The SB35 allows users to upgrade the software using the HK Remote app from mobile devices. To upgrade the software in the SB35 system, you will require a mobile device with Android or iOS operating system. The software upgrade in SB35 can be performed using the Bluetooth channel to communicate with the mobile device.

HDMI 1, HDMI 2 and HDMI 3: HDMI connections transmit digital audio and video signals between the devices. If you have source devices with HDMI connectors, you should use it for the best possible audio and video performance quality.

HDMI TV: Connect your television to this input using the supplied HDMI cable. If your TV supports Audio Return Channel (ARC), you can use the supplied HDMI cable to connect to your television by enabling the TV ARC output. Check the TV settings, if the ARC does not work. The ARC will send back the audio signal from the television automatically to the SABRE SB35. If your television does not support ARC, you will have to run an additional optical or analog cable base on your television compatibility.

SABRE SB35 Subwoofer Rear Panel Controls

The rear panel of the SABRE SB35 subwoofer provides the following:

- Crossover adjustment
- Wireless pairing button
- Wireless pairing indicator
- Phase adjustment

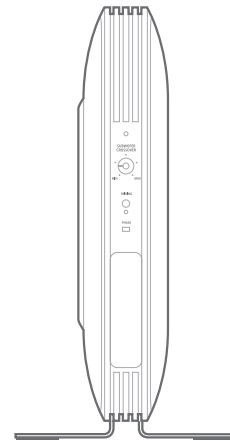

Crossover adjustment: This control adjusts the SABRE SB35 subwoofer's crossover. The higher you set the Crossover control, the higher in frequency the subwoofer will operate and the more its bass will overlap that of the soundbar. This adjustment helps you achieve a smooth transition of bass frequencies between the subwoofer and the soundbar for a variety of different rooms and subwoofer locations.

Wireless pairing button: Press the wireless subwoofer pairing button to initiate wireless pairing between soundbar and the wireless subwoofer.

Wireless pairing indicator: This indicator in the subwoofer displays the following:

- Wireless pairing: Blue light blinks with a cycle of 300 ms
- Wireless connection: Blue light constant
- Wireless disconnection: Blue light blinks with a cycle of 1s

Phase Adjustment (0-180°): The phase adjustment switch determines whether the subwoofer driver's piston-like action moves in and out in phase with the speakers in the soundbar. If the subwoofer needs to play out of phase with the soundbar speakers, the sound waves from the soundbar can cancel out some of the sound waves from the subwoofers, reducing bass performance and sonic impact. This phenomenon depends, up to some extent, on the placement of the subwoofer and soundbar relative to each other in the room.

Remote Control Functions

The following buttons are available in the SABRE SB35 remote control:

1. Power
2. HDMI Inputs 1/2/3
3. Optical, HDMI TV ARC, Aux in
4. Bluetooth
5. Volume control +/-
6. Mute
7. Independent Subwoofer Volume control +/-
8. Harman Volume
9. Stereo, Virtual modes
10. Wave mode - Select room size
 - a. Small
 - b. Medium
 - c. Large

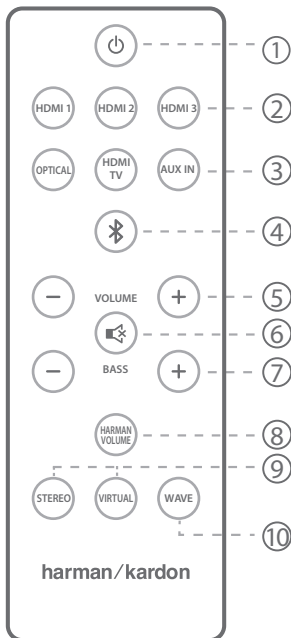

Power button: To bring the SABRE SB35 to Operational mode from Standby mode, press the Power button (The Power indicator on the SABRE SB35 will turn white).

To put the system in the Standby mode, press the Power button while the system is switched ON (The Power indicator on the SABRE SB35 will turn amber). If you do not press the Power button, the SABRE SB35 and the subwoofer will automatically go into Standby mode approximately in 10 minutes after the audio input signal stops.

HDMI inputs 1, 2 and 3: Press a button to select an active source – HDMI 1, HDMI 2 or HDMI 3.

Optical, HDMI ARC, AUX input: Press this button to select the desired source.

Bluetooth: Short press to switch to Bluetooth source. Press and hold to make the unit go to pairing mode.

NOTE: SABRE SB35's Bluetooth device name is SABRE SB35 and the password is 0000.

Volume control +/-: Press the (-) button to reduce the volume; press the (+) button to increase the volume.

Mute: Press this button to mute the system.

Subwoofer volume control +/-: Use this to control the subwoofer's volume. Press "+" to increase the subwoofer's volume. Press "-" to decrease the subwoofer's volume.

Harman Volume: This button cycles the Harman Volume function between high, low and off. Harman volume is an advanced digital signal processing technology to control playback volume. It evens out the volume level on everything you watch, improving your listening experience. Once you choose the volume level, Harman Volume does the rest. It helps you avoid volume increase from commercials, volume differences when you change channels or switch sources. It helps you listen to the perfect sound of the dialogs.

Stereo, Virtual, Wave mode: Press this button to change the surround sound to Stereo, Virtual or WAVE mode. In WAVE mode you can press the WAVE button to adjust the surround effect depending on your room size: Small, Medium or Large.

NOTE: Feel free to experiment with this adjustment to find the effect that works best for your listening room and seating arrangement. As with the Virtual mode, in the HARMAN WAVE mode, the soundbar's digital signal processing also creates rear ambience that adds depth to the sound presentation for conventional stereo and MP3 sources.

Placing the SABRE SB35

The SABRE SB35 soundbar can be placed on a table and can be wall-mounted as well.

Placing the SABRE SB35 on a Table

If your TV is placed on a table, you can place the soundbar on the table directly in front of the TV stand, centered with the TV screen. Use the table stand provided.

To place the soundbar on a table:

1. Place the rubber pad on the table stand provided.



2. Slide the soundbar into the table stand.

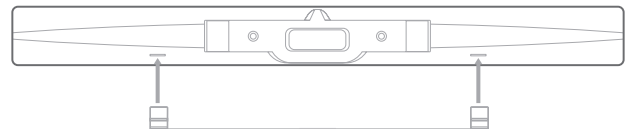

The soundbar will be placed on the table.



NOTE: The rubber pads should be placed in the soundbar at the factory during manufacturing of the soundbar. If they are not present, check inside the accessories box and place them before insertion.

Wall-Mounting the SABRE SB35

If your TV is attached to a wall, you can use the included wall-mount brackets to mount the SABRE SB35 on the wall directly below the TV screen.

1. Determine the location for the SABRE SB35 soundbar on the wall. Make sure that the top of the soundbar does not block your view of the TV screen when it is mounted on the wall.
2. Place the wall mount stand at the desired place.
3. Place the rubber pads on the wall mount bracket provided.

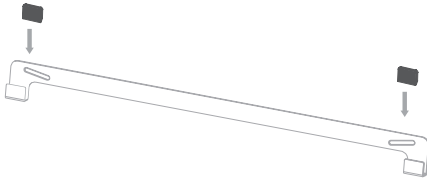

4. Place the sound bar on the wall mount bracket.

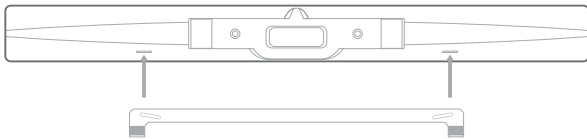

NOTE: The rubber pads should be placed in the soundbar at the factory during manufacturing of the soundbar. If they are not present, check inside the accessories box and place them before insertion.

Placing the SABRE SB35 Subwoofer

The performance of a subwoofer is directly related to its placement in the listening room and its physical position relative to the other speakers in the system. While it is true that in general, our ears do not hear directional sounds at the low frequencies where subwoofers operate, when installing a subwoofer within the limited confines of a room, the reflections, standing waves and absorptions generated within the room strongly influences the performance of any subwoofer system. As a result, the specific location of the subwoofer in the room does become important to the amount and quality of bass that is produced. The SABRE SB35 subwoofer can be placed on floor and can be wall-mounted as well.

Placing the Subwoofer on Floor

To place the subwoofer on floor:

1. Place the floor stand at the desired place.

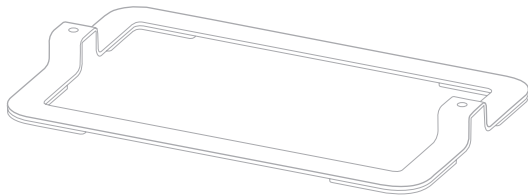

2. Fix the subwoofer on the stand with the screws provided.



The subwoofer will be placed on floor.

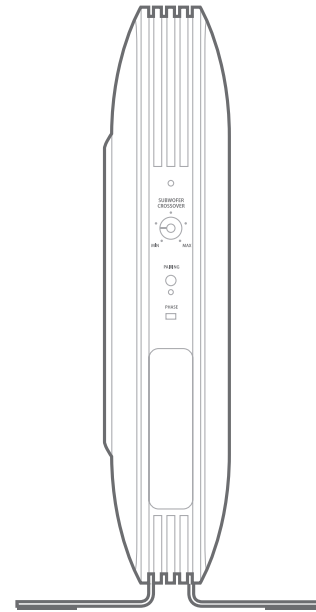

Wall-Mounting the subwoofer

To wall-mount the subwoofer:

1. Determine the location for the Subwoofer on the wall.
2. Fix the wall mount stand at the desired place.
3. Place your subwoofer on the wall-mount bracket.

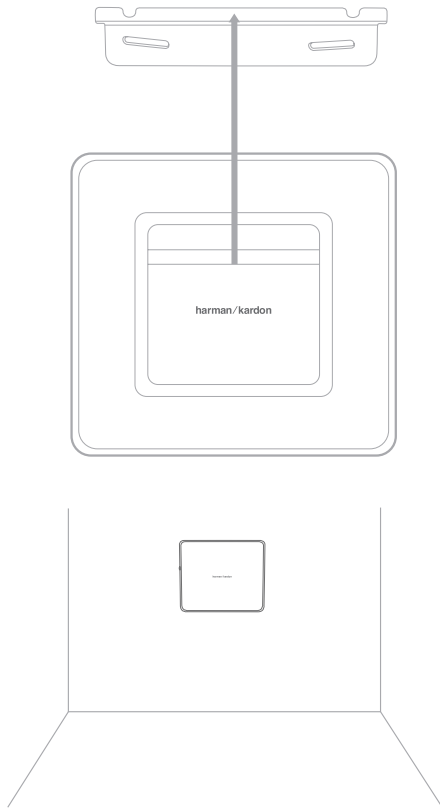

You may wall-mount the subwoofer in the positions as represented below.

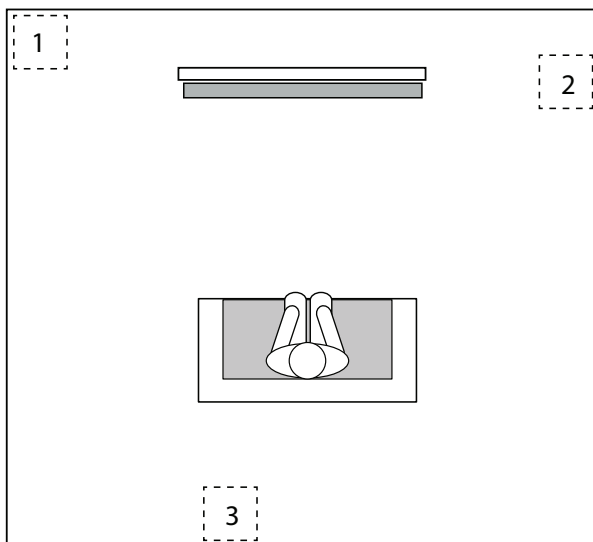

- Placing it in a corner, that is position (1) will maximize amount of bass in the room. However, corner placement can also increase the destructive effect of standing waves on bass performance. This effect can vary depending on the listening position – some listening positions may yield very good results while others may have far too much (or too little) bass at certain frequencies.
- Placing the subwoofer along the same plane as the soundbar that is, position (2) can produce the best integration between the sound of the subwoofer and that of the soundbar. The best performance could even result from placing the subwoofer behind the listening position (3).

You can experiment with subwoofer placement by temporarily placing the subwoofer in the listening position and playing music with strong bass content. Move it to various locations in the room while the system is playing until you determine the location of best bass performance. Once you find the ideal location, place the subwoofer in that location.

IMPORTANT: The maximum wireless operating distance between the soundbar and subwoofer is approximately 15m (50 feet).

Placing the Subwoofer under a Couch or Furniture

The subwoofer can be placed flat under a couch set or a furniture without any additional accessories.

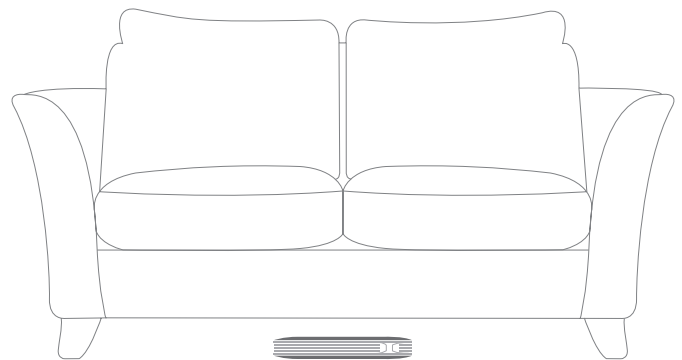

Connections

Audio/Video Connections

HDMI ARC TV Out: If your TV has an HDMI input, use the supplied HDMI cable to connect it to the SB35's HDMI ARC TV Out connection. The SB35 will pass video from source devices connected to its HDMI Input connectors; along with its own on-screen display information to the TV. If your TV is equipped with HDMI ARC Function, you can feed its sound to the SB35 via the HDMI ARC TV Out connection, and it will not require additional audio connections to the SB35. The HDMI ARC signal is active when the HDMI TV source is selected.

The HDMI ARC function may require to be activated from your television menu to work. You may refer to your TV owner's manual to activate the HDMI ARC function.

If your television is not equipped with the HDMI ARC option, you will have to connect an optical or analog cable from your television to the soundbar in addition to the HDMI to get the audio.

NOTE: The SABRE SB35's On-screen Information Display (OSD) only appears through the HDMI TV Out connector. If you want to see the SABRE SB35's OSD, you need to connect its HDMI ARC TV Out connector to your TV even if you are not connecting any HDMI video source devices to the SABRE SB35's HDMI In 1/2/3 connectors.

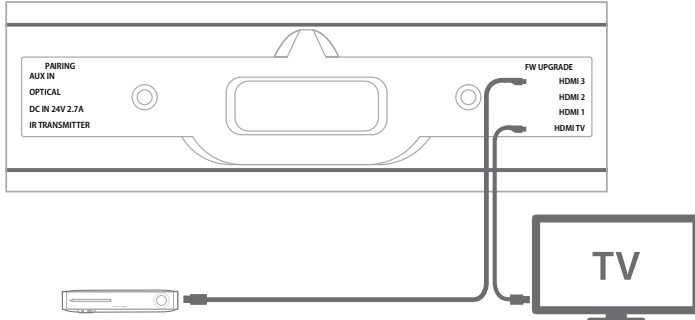

HDMI In 1/2/3: If any of your source devices have HDMI connectors, connect them to the soundbar's HDMI In 1/2/3 connectors for the best possible video and audio performance quality. Since the HDMI cable carries both digital video and digital audio signals, you do not have to make any additional audio connections for source devices you connect via HDMI connectors.

NOTE: The SABRE 35 uses micro HDMI to HDMI connector and you have to purchase micro HDMI cables as these are not provided with SB35.

Aux In and Optical In connections: If your TV and/or source devices do not have HDMI connections, you can use the supplied audio cable and/or optical cable to connect your TV and one source device to the SABRE SB35's Aux In and/or Optical In connectors, respectively.

Power Connections

After you have made and verified all of the source connections above:

1. Connect the DC power supply to the soundbar's power connection. Then plug the supplied AC cord into the DC power supply and into an active, unswitched AC outlet..

IMPORTANT: DO NOT plug this cord into the accessory outlets found on some audio components.

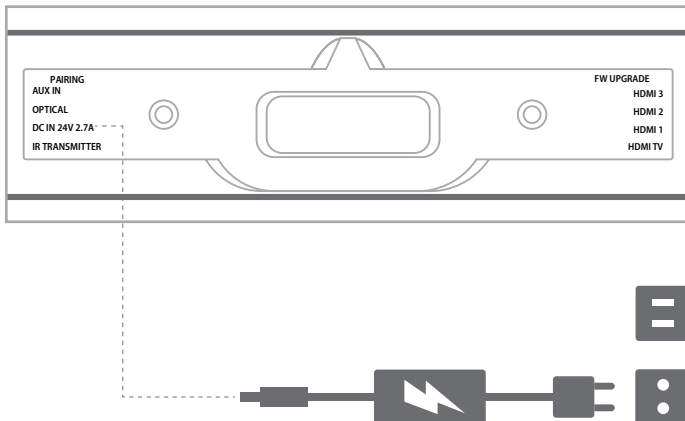

2. Plug the subwoofer's power cord into an active, unswitched AC outlet.

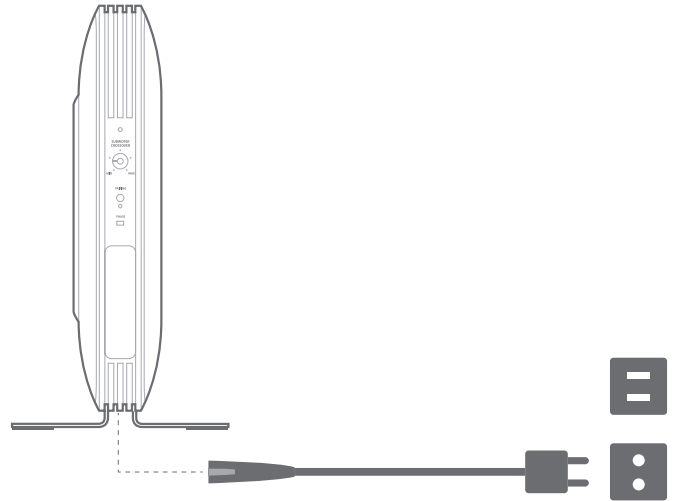

Operation

Turning the SABRE SB35 ON and OFF

Manually: To turn the SABRE SB35 ON or OFF manually, short press the soundbar's Power button. Press the Power button on either the soundbar or the remote.

NOTE: If you put the soundbar into Standby manually, you can turn it back ON by manually pressing the Power button.

Auto turn-on: The SABRE SB35 has a signal detector that will automatically turn the unit ON when it senses an audio signal on HDMI inputs using CEC command (compatible product and/or television) or a Bluetooth streaming. The auto turn-on mode is activated for analog or optical inputs only when the SABRE SB35 goes in auto Standby on sensing the same audio input signal.

Auto turn-off: The SABRE SB35 will automatically enter Standby mode if no audio signal is detected at any of its Source input connections for approximately 10 minutes. If you have programmed the SABRE SB35 to respond to the ON and OFF commands of your TV remote, you can manually put the SABRE SB35 into the Standby mode without pressing the Power button.

IMPORTANT: If you will be away from home for an extended period of time, or if you will not be using the system for an extended period, we recommend that you unplug from the AC outlet.

Turning the Subwoofer ON and OFF

The subwoofer will automatically turn itself ON when it senses an audio signal, and it will return to Standby mode when the SABRE SB35 goes into standby mode.

Pairing the Units for Wireless Operation

After turning the soundbar and subwoofer ON for the first time, you will need to pair the subwoofer and soundbar so they both operate at the same wireless frequency. To pair the units, press the Wireless Pairing switches on both the units within 30 seconds interval. The units will communicate with each other and operate at the same frequency.

NOTE: The subwoofer enters Standby mode if the pairing gets disconnected for at least 30 seconds.

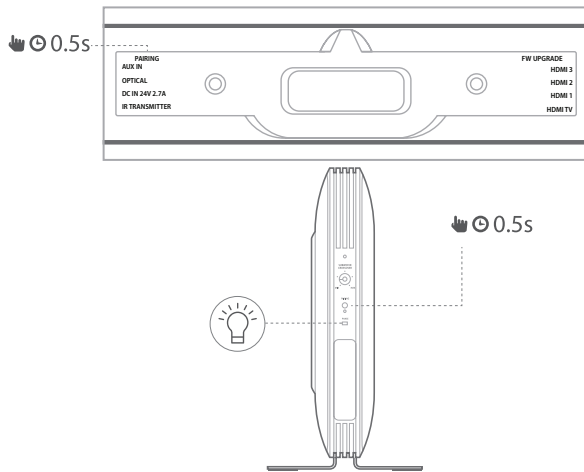

The LED will stop blinking and remain a solid blue color when paired

Front Panel and On-screen Information Display (OSD)

The SABRE SB35 is equipped with a front panel display behind the grill of the soundbar as well as a On-Screen information Display (OSD) that will appear on the screen of a TV connected to the HDMI ARC TV Out connector to help you verify the operating status of the SB35. The OSD will overlay on top of the TV's video program for five seconds after pressing a button on the soundbar or remote. (When you select an audio-only source connection such as Aux, Optical, or Bluetooth, the OSD information will overlay a black screen with Harman Kardon logo). The front panel display will also light up for 5 seconds after pressing a button on the soundbar or remote in the same manner.

- **Volume control:** When changing the volume of the system, both will display the volume level indication.
- **Subwoofer volume control:** When changing the subwoofer volume, independent from the main volume control, both will display the subwoofer volume level indication.
- **Mute:** When the audio signal is mute, both will display **Mute**.
- **Source:** The OSD and the front panel will indicate the source input selected.
- **Harman Volume:** The OSD and the front panel will indicate if Harman volume is high, low or off.

- **Surround mode:** The OSD and the front panel will indicate if the Soundbar is in Stereo or Harman Display surround mode.
- **Dolby® Digital:** If a Dolby Digital audio stream is sensed by the soundbar, both will indicate that the Dolby Digital decoding is active.
- **DTS®:** If a DTS audio stream is sensed by the soundbar the both will indicate that the DTS decoding is active.
- **Bluetooth:** The following information is displayed in the OSD and the front panel during Bluetooth operation:
 - Bluetooth pairing - When the SABRE SB35 is in pairing mode
 - Bluetooth connected - When the connection to a new device is successful
 - Bluetooth - When the source Bluetooth is operated

In addition to the status information, the OSD will also display messages if the selected HDMI connection cannot be detected or if the video signal is lost.

Operating through Bluetooth®

To wirelessly stream audio to the SABRE SB35 from a Bluetooth-enabled device:

1. Confirm that the SABRE SB35 is in the Bluetooth pairing mode. The OSD will display **Bluetooth pairing**.



2. Place the device in pairing mode.
3. Use the device's Bluetooth pairing menu to pair it with the SABRE SB35. The system will appear as SABRE SB35 in the list of Bluetooth available devices. The OSD will display **Bluetooth connected**.

When the SABRE SB35's Bluetooth button LED illuminates constantly, it is paired with the device and you can stream audio via Bluetooth from the device to the SABRE SB35. To listen to audio from the Bluetooth device, press the source button until the Bluetooth source indicator LED illuminates.



To disconnect the Bluetooth device, press and hold the soundbar's Bluetooth button until the LED begins flashing.

NOTE:

- You can manually switch sources to the paired Bluetooth device by pressing the SABRE SB35's Bluetooth button.
- If you switch the soundbar to a different source while a paired Bluetooth device is streaming to the soundbar, the soundbar will send a STOP command and the Bluetooth device will stop streaming.

IMPORTANT: When pairing Bluetooth device for first time, it may reset the volume level to maximum. This will happen only for the first time.

Switching Source

Press the system's Source button to cycle between the sources in the following order:

1. Bluetooth
2. AUX input
3. Digital Optical In
4. HDMI ARC
5. HDMI 1
6. HDMI 2
7. HDMI 3

Adjusting the SABRE SB35's Volume

Soundbar

Press the SABRE SB35's Volume Up and Down buttons to raise and lower the system's volume one press at a time. Hold down the button to raise or lower the volume continuously.

NOTE: The lowest setting of the Volume Down button will mute the system.



For the best sound, we recommend turning your TV's built-in speakers off. Check your TV's owner's manual to find out how to do this. If there is no way to turn your TV's speakers off, you can adjust the TV's volume so that your SB35 system will always supply most of the sound:

1. Using the volume buttons on your TV, turn its volume all the way down.
2. Then use the soundbar's Volume Up/Down buttons to set the sound to a comfortable listening level.

This way, your SABRE SB35 system should always be louder than your TV's speakers.

NOTE: If you play the SABRE SB35 at more than 50% of max volume and turn the soundbar off using the power button, the system will automatically reset at 50% of the max volume.

Muting the System

To mute the SABRE SB35 system:

- Short press soundbar's Volume + and – buttons together.

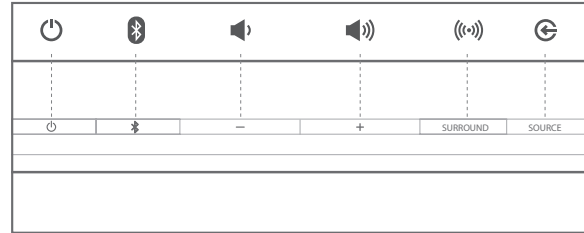

- Press the **Mute** button on the remote control. Press it again to unmute.

NOTE: To unmute, press any Volume button.

SABRE SB35 Surround Mode

The unit supports three surround modes:

- Music (Stereo)
- Virtual
- WAVE (Large, Medium, Small room modes)

Press the surround button on the top panel to select the desired Surround mode or select the Surround modes from the remote control.

Subwoofer Crossover Adjustment

The subwoofer's Crossover control adjusts the subwoofer's low pass crossover frequency. The higher you set the Crossover control, the higher in frequency the subwoofer will operate and the more its bass will overlap that of the soundbar. This adjustment helps you achieve a smooth transition of bass frequencies between the subwoofer and the soundbar for a variety of different rooms and subwoofer locations.

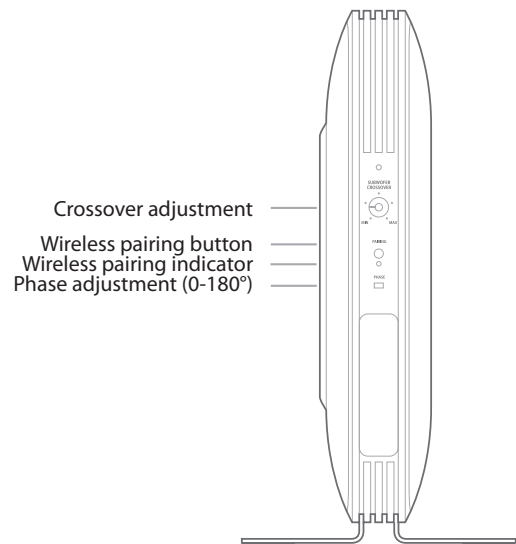

To set the Crossover control, listen for the smoothness of the bass. If the bass seems too strong at certain frequencies, try a lower Crossover control setting. If the bass seems too weak at certain frequencies, try a higher Crossover control setting.

Subwoofer Phase Adjustment (0-180°)

This switch determines whether the subwoofer's piston-like action moves in and out in phase with the speakers in the soundbar. If the subwoofer were to play out of phase with the soundbar speakers, some of the sound waves produced by the soundbar and subwoofer could be canceled out at some frequencies, reducing the bass performance and sonic impact. This phenomenon depends on the relative placement of all the speakers in the room up to some extent.

Programming SABRE SB35 to Respond to Your TV Remote

You can program the SABRE SB35 to make it respond to your TV remote's power, mute, volume up and volume down commands. This programming lets you control your whole system with your TV remote. Before beginning to program the SABRE SB35, have your TV remote in hand. We recommend sitting down in front of the soundbar.

NOTE: Some steps will time out, so read through this entire procedure before you begin.

Have the TV remote in hand. When you start programming the remote, be ready to aim the TV remote control in front of the soundbar from about 300 mm – 900 mm (about 12 – 36 inches) away.

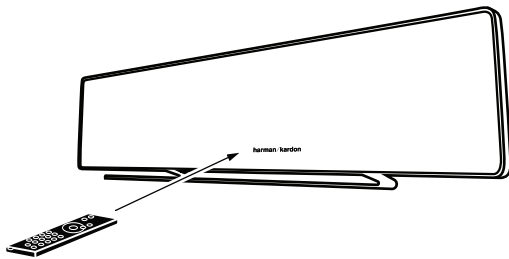

To program the Power, Volume and Mute command:

1. Ensure that the SABRE SB35 is switched ON.
2. On the soundbar, press and hold the Surround button until the display on the SABRE SB35 indicate you are in learning mode.

To program the Power command:

- Press the Power button on the soundbar and press the power button on the TV remote control.

To program the Volume command:

- Press the Volume + button on the soundbar and press the Volume + button on the TV remote control.
- Press the Volume – button on the soundbar and press the Volume – button on the TV remote control.

To program the Mute command:

- Press the Volume + and Volume – button on the soundbar and then press the Mute button on the TV remote.

Once you complete programming your remote control, press and hold the soundbar's Surround button to exit the programming mode.

NOTE: If you would like to program a new TV remote control or you are missing a command, restart the whole process.

If you would like to cancel the learning, reset the SB35. Put the SB35 in Standby mode, press and hold the Surround and Volume – button simultaneously. Once factory defaults are restored, the SB35 surround button will flash white for one second, then the unit will enter into operational mode.

Resetting Factory Default Settings

If you want to restore all the settings to factory default setting, press Surround and Volume – keys in standby mode.

The factory default setting values are shown in the table below.

Item	Value
Source	Optical
System Volume	-20dB
Surround Mode	Stereo
WAVE	Medium
Harman Volume	Low

Troubleshooting

If your SABRE SB35 system is not performing the way you think it should, check if the problem is covered in this section before calling your dealer or contacting a Harman Kardon representative.

Problems	Solutions
If the SABRE SB35 soundbar does not turn ON	<ul style="list-style-type: none"> Check if the SABRE SB35 power supply's AC cord is plugged into a working AC outlet and that the power supply is plugged into the SABRE SB35.
If the SABRE SB35 subwoofer does not turn ON	<ul style="list-style-type: none"> Check if the subwoofer's power cord is plugged into a working AC outlet. Check if the subwoofer's AC fuse has blown. See Subwoofer Rear Panel Controls.
If there is no sound coming from both the soundbar and the subwoofer	<ul style="list-style-type: none"> Check if soundbar SABRE SB35 is ON (the Power Indicator should be white). Check if the cable connecting the TV or other source component to soundbar is properly connected at both ends. Check if the soundbar's Source Selector is set to the correct source and that source is playing an audio signal. Check if the system is mute. If the system is mute, press the volume buttons to unmute the system. Check if the soundbar's volume is not turned all the way down (the lowest setting of the Volume Down button will mute the system).
If there is no sound coming only from the SABRE SB35 subwoofer	<ul style="list-style-type: none"> Check if the Subwoofer Volume Control is not turned all the way down. Check if the wireless connection is still active (blue LED constant in the back of the subwoofer). If the LED is flashing blue, then restart the pairing process. Move the subwoofer closer to the soundbar. The maximum wireless operation distance is 15 m (50 feet).
If the system's sound is distorted	<ul style="list-style-type: none"> Check the source component to see if the distortion is coming from it, and not from soundbar.
If the bass output is not loud enough	<ul style="list-style-type: none"> Make sure the subwoofer volume level is not set at minimum. Increase the subwoofer volume control using the remote control. Move the subwoofer at a corner of the room. Move the subwoofer closer to the seating location.
When I turn off my SABRE SB35, it resets the volume	<ul style="list-style-type: none"> This is actually a feature. If the soundbar is playing at more than 50% of maximum volume, when power off the volume is automatically reset to 50% of maximum volume when turning it on.
My TV is ON and my SABRE SB35 is in Standby. When I turn off my television, it turns my Soundbar on.	<ul style="list-style-type: none"> This is actually related to some issue on some television having wrong Hot Plug Detection (HPD) protocol. You can activate/deactivate HPD protocol by pressing the Surround and Volume – buttons simultaneously.

Specifications

SABRE SB35	
Frequency response	43Hz – 22kHz (-6dB)
SABRE SB35 CTR Soundbar	
Midrange transducers	1.75" (45 mm) panel, 6pcs
High-Frequency transducers	1" (25 mm) dome, 4pcs
Amplifier power	L/R: 4 x 20 W, Centre: 4 x 15 W
Power requirement	24V DC, 2.7 A
Dimension	1150 mm x 110mm x 32 mm
Weight	2.6 kg
SABRE SB35 (Flat Subwoofer)	
Transducer	4.5" (112 mm) cone, 2pcs
Enclosure type	Ported
Power requirement	100-240V AC, 50Hz/60Hz, 100 W
Dimension	460 mm x 390 mm x 86 mm
Amplifier power	100 Watts
Weight	5.8 kg



HARMAN

HARMAN International Industries, Incorporated
8500 Balboa Boulevard, Northridge, CA 91329 USA
www.harmankardon.com

© 2013 HARMAN International Industries, Incorporated. All rights reserved.
Features, specifications and appearance are subject to change without notice.

Harman Kardon is a trademark of HARMAN International Industries, Incorporated, registered in the United States and/or other countries.

The Bluetooth® word mark and logos are registered trademarks owned by Bluetooth SIG, Inc. and any use of such marks by HARMAN International Industries, Incorporated is under license. Other trademarks and trade names are those of their respective owners.

"Made for iPod," "Made for iPhone," and "Made for iPad" mean that an electronic accessory has been designed to connect specifically to iPod, iPhone, or iPad, respectively, and has been certified by the developer to meet Apple performance standards. Apple is not responsible for the operation of this device or its compliance with safety and regulatory standards. Please note that the use of this accessory with iPod, iPhone, or iPad may affect wireless performance.

Made for iPhone 5, iPhone 4S, iPhone 4, iPhone 3GS, iPad (3rd and 4th generation), iPad 2, iPad, iPad mini, iPod touch (3rd through 5th generation).

iPad, iPhone, iPod, and iPod touch are trademarks of Apple Inc., registered in the U.S. and other countries.

Manufactured under license from Dolby Laboratories. Dolby, and the double-D symbol are trademarks of Dolby Laboratories.

DTS, DTS-HD, the Symbol, & DTS or DTS-HD and the Symbol together are registered trademarks of DTS, Inc. © DTS, Inc. All Rights Reserved.

The terms HDMI, the HDMI logo, and High-Definition Multimedia Interface are trademarks or registered trademarks of HDMI Licensing LLC in the United States and other countries.

harman / kardon
by HARMAN